



Product Description

The Sirenza Microdevices STQ-2016-3 is a direct quadrature modulator targeted for use in W-CDMA applications. This device features a 700-2500 MHz operating frequency band, excellent carrier and sideband suppression, and a low broadband noise floor.

The STQ-2016-3 uses silicon germanium (SiGe) device technology and delivers a typical channel power of -11 dBm with adjacent channel power less than -65 dBc. A digital input shut-down feature is included that, when enabled, attenuates the output by 60 dB. The device is packaged in an industry standard 16 pin TSSOP with exposed paddle for superb RF and thermal ground. The STQ-2016-3Z is packaged in a RoHS compliant and Green 16-pin TSSOP with matte tin finish.

Functional Block Diagram

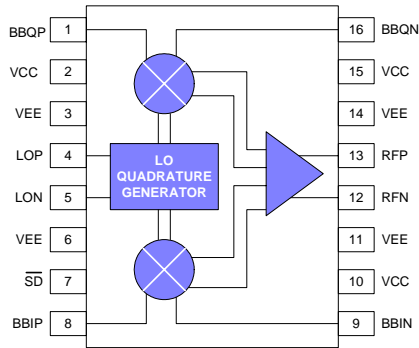

STQ-2016-3

STQ-2016-3Z  RoHS Compliant & Green Package

700-2500 MHz Direct Quadrature Modulator

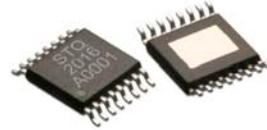

16 pin TSSOP with Exposed Ground Pad

Package Footprint: 0.197 x 0.252 inches, (5.0 x 6.4 mm)

Package Height: 0.039 inches (1.0 mm)

Product Features

- Excellent carrier feedthrough, -40 dBm constant with output power
- +4.0 dBm output P1dB
- Wide baseband input, DC - 500 MHz
- Superb phase accuracy and amplitude balance, ± 0.5 deg./ ± 0.2 dB
- Very low noise floor, -157 dBm/Hz
- Low ACP, -65 dBc

Applications

- W-CDMA Transmitters

Product Specifications – W-CDMA Modulation (See Table 1 for Test Conditions)

Parameters	Comments	Unit	869-894 MHz			1930-1990 MHz			2110-2170 MHz			Type*
			Min.	Typ.	Max.	Min.	Typ.	Max.	Min.	Typ.	Max.	
Channel Power	Guaranteed through Output Power test as specified on Page 2	dBm	-13	-11	-9	-14.5	-12.5	-10.5	-15	-13	-11	E
Power Flatness	Range across frequency band	dB		0.25	0.5		0.25	0.5		0.25	0.5	C,D
Adjacent Channel Power	Guaranteed through IM3 test as specified on Page 2	dBc		-65	-63		-65	-63		-65	-63	E
First Alternate Channel Power		dBc		-75	-68		-73	-68		-73	-68	C,D
Second Alternate Channel Power		dBc		-75	-68		-73	-68		-73	-68	C,D
Broadband Noise Floor	60 MHz offset from carrier	dBm/Hz		-157	-156		-157	-156		-156	-155	C,D
Signal-to-Noise Ratio	Noise Offset: 60 MHz, Measured in a 3.84 MHz bandwidth	dB	79	81		77	79		76	78		C,D

*Type Definition: A = 100% tested (see Table 2 for conditions), B = Sample tested, C = Characterized on samples over temperature and Vcc, D = Design parameter, E = 100% tested through correlated CW parameter, I = Device input specification.

The information provided herein is believed to be reliable at press time. Sirenza Microdevices assumes no responsibility for inaccuracies or omissions. Sirenza Microdevices assumes no responsibility for the use of this information, and all such information shall be entirely at the user's own risk. Prices and specifications are subject to change without notice. No patent rights or licenses to any of the circuits described herein are implied or granted to any third party. Sirenza Microdevices does not authorize or warrant any Sirenza Microdevices product for use in life-support devices and/or systems.

Copyright 2001 Sirenza Microdevices, Inc. All worldwide rights reserved.
303 South Technology Court Broomfield, CO 80021

Phone: (800) SMI-MMIC

<http://www.sirenza.com>
EDS-104229 Rev B



STQ-2016-3 Direct Quadrature Modulator

Product Specifications – Parameter Variation, W-CDMA Modulation (See Table 1 for Test Conditions)

Parameters	Comments	Unit	Vcc (V)			Temp. (Deg. C)			Type*
			4.75	5.0	5.25	-40	+25	+85	
Channel Power		dBm	-13.05	-13	-12.95	-12.15	-13	-13.50	C,D
Adjacent Channel Power		dBc	-64.3	-65	-65.4	-64.95	-65	-65.25	C,D
First Alternate Channel Power		dBc	-72.9	-73	-72.9	-75.1	-73	-72.9	C,D
Second Alternate Channel Power		dBc	-73.25	-73	-72.9	-75.4	-73	-72.5	C,D
Broadband Noise Floor	60 MHz offset from carrier	dBm/Hz	-156.3	-156	-155.95	-156.25	-156	-155.4	C,D
Signal-to-Noise Ratio	Noise Offset: 60 MHz, Measured in a 3.84 MHz bandwidth	dB	77.8	78	77.8	79	78	77	C,D

Product Specifications – Parameter Variation, W-CDMA Modulation (See Table 1 for Test Conditions)

Parameters	Comments	Unit	LO Drive (dBm)			I/Q Drive (Vpp, Diff.**)			Type*
			-1	+3	+7	1.0	1.7	2.5	
Channel Power		dBm	-13.05	-13	-12.95	-16.7	-13	-10.2	C,D
Adjacent Channel Power		dBc	-65.75	-65	-64.5	-68.7	-65	-58.6	C,D
First Alternate Channel Power		dBc	-72.3	-73	-73.1	-68.3	-73	-74.7	C,D
Second Alternate Channel Power		dBc	-72.3	-73	-73.05	-67.3	-73	-73.7	C,D
Broadband Noise Floor	60 MHz offset from carrier	dBm/Hz	-155.25	-156	-156.4	-156.7	-156	-155.2	C,D
Signal-to-Noise Ratio	Noise Offset: 60 MHz, Measured in a 3.84 MHz bandwidth	dB	77.5	78	78.3	75	78	80	C,D

Product Specifications – RF Output, CW Modulation (See Table 2 for Test Conditions)

Parameters	Additional Test Conditions/Comments	Unit	700-1000 MHz			1700-2500 MHz			Type*
			Min.	Typ.	Max.	Min.	Typ.	Max.	
RF Frequency Range		MHz	700		1000	1700		2500	A
Output Power		dBm	-13	-10.5	-9.0	-13	-11.5	-9	A,C
RF Port Return Loss	Matched to 50Ω (refer to schematics on pages 14 and 15)	dB		20			16		D
Output P1dB	(I/Q inputs = 3.74 Vp-p differential typical)	dBm	+3.0	+4.0		0	+3.0		A,C
Carrier Feedthrough		dBm		-40	-34		-40	-32	A,C
Sideband Suppression		dB	34	40		34	40		A,C
IM3 Suppression	Two-tone baseband input @ 1.2Vp-p differ- ential per tone	dB	46	50		47	53		A,C
Quadrature Phase Error		Deg.	-2	±0.5	+2	-2	±0.5	+2	D
I/Q Amplitude Balance		dB	-0.2	±0.05	+0.2	-0.2	±0.05	+0.2	D
Supply Voltage (Vcc)		V	+4.75	+5	+5.25	+4.75	+5	+5.25	I
Supply Current		mA	60	73	86	60	73	86	A
Device Thermal Resistance	Junction-Case	°C/W		25			25		D

*Type Definition: A = 100% tested (see Table 2 for conditions), B = Sample tested, C = Characterized on samples over temperature and Vcc, D = Design parameter, E = 100% tested through correlated CW parameter, I = Device input specification.



Product Specifications – LO Input

Parameters	Additional Test Conditions/Comments	Unit	Min.	Typ.	Max.	Type*
LO Frequency		MHz	700		2500	I
LO Drive Level	Recommended/Optimum Levels	dBm	-1	+3	+7	I
LO Port Return Loss	matched to 50Ω (see schematic on page 12)	dB		16		D

Product Specifications – Shut-Down Input (Pin 7)

Parameters	Additional Test Conditions/Comments	Unit	Min.	Typ.	Max.	Type*
Shut-Down Current		mA		42	60	A
Shut-Down Attenuation		dB		60		D
Shut-Down Pin Resistance	@ 1MHz	kohm		11.9		D
Shut-Down Pin Capacitance	@ 1MHz	pF		5.2		D
Shut-down Control Voltage Thresholds	Shut-down disabled (normal operation)	V	3.75		Vcc	I
	Shut-down enabled	V	0.0		1.5	I
Shut-Down Settling Time		ns		<450		D

Product Specifications – Baseband Modulation Input

Parameters	Additional Test Conditions/Comments	Unit	Min.	Typ.	Max.	Type*
Baseband Frequency Input	-3dB bandwidth, baseband inputs terminated in 50 ohms	MHz	DC		500	I
Baseband Input Resistance	per pin	kohms		4.4		D
Baseband Input Capacitance	per pin	pF		0.5		D

*Type Definition: A = 100% tested (see Table 2 for conditions), B = Sample tested, C = Characterized on samples over temperature and Vcc, D = Design parameter, E = 100 % tested through correlated CW parameter, I = Device input specification.

**Peak-to-Peak Differential ($V_{pp, Diff.}$) Baseband Voltage Definition:

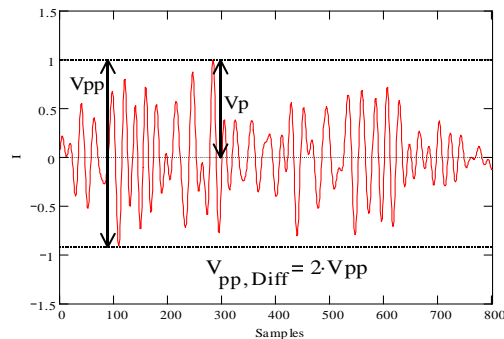

Plot of Single-Ended W-CDMA Baseband Signal (BBIP)

Table 1. W-CDMA Test Conditions
(Unless otherwise noted)

V _{CC} (pins 2,10,15)	+5V
T _A	+25°C
Baseband Input (Pins 1, 8, 9, 16)	1.9V DC bias, W-CDMA Test Model 1 w/ 64 DPCH (PAR = 10.54), 850mVp-p per pin = 1.7 Vp-p differential drive, I and Q signals in quadrature
LO Input (Pins 4, 5)	+4.0 dBm @ 2140 MHz

Table 2. CW Test Conditions
(for all product specifications unless otherwise noted)

V _{CC} (pins 2,10,15)	+5V
T _A	+25°C
Baseband Input (Pins 1, 8, 9, 16)	1.9V DC bias, 200kHz frequency, 300 mVp-p per pin = 600 mVp-p differential drive, I and Q signals in quadrature
LO Input (Pins 4, 5)	-5 dBm @ 1960 MHz

Pin Out Description

Pin #	Function	Description	Additional Comments
1	BBQP	Q-channel baseband input, positive terminal	Nominal DC bias voltage is 1.9V (biased internally)
2	VCC	Positive supply (+5V)	
3	VEE	Ground	
4	LOP	Local oscillator input, positive terminal	Nominal DC voltage is 2.0V. Input should be AC-coupled.
5	LON	Local oscillator input, negative terminal	Nominal DC voltage is 2.0V. Input should be AC-coupled.
6	VEE	Ground	
7	SD	Shut-down control	Logic high = normal operation; Logic Low = shut-down enabled.
8	BBIP	I-channel baseband input, positive terminal	Nominal DC bias voltage is 1.9V (biased internally)
9	BBIN	I-channel baseband input, negative terminal	Nominal DC bias voltage is 1.9V (biased internally)
10	VCC	Positive supply (+5V)	
11	VEE	Ground	
12	RFN	RF output, negative terminal	Nominal DC voltage is 2.4V. Output should be AC-coupled.
13	RFP	RF output, positive terminal	Nominal DC voltage is 2.4V. Output should be AC-coupled.
14	VEE	Ground	
15	VCC	Positive supply (+5V)	
16	BBQN	Q-channel baseband input, negative terminal	Nominal DC bias voltage is 1.9V (biased internally)

Absolute Maximum Ratings

Parameters	Value	Unit
Supply Voltage (VCC)	6.0	V _{DC}
LO, RF Input (LOP, LON, RFP, RFN)	+10	dBm
Baseband Min Input Voltage (BBIP, BBIN, BBQP, BBQN)	0	V _{DC}
Baseband Max Input Voltage (BBIP, BBIN, BBQP, BBQN)	3	V _{DC}
Operating Temperature	-40 to +85	°C
Storage Temperature	-65 to +150	°C

Operation of this device beyond any one of these limits may cause permanent damage. For reliable continuous operation the device voltage and current must not exceed the maximum operating values specified in the table on page one.

Part Number Ordering Information

Part Number	Reel Size	Devices/Reel	
		Min.	Max.
STQ-2016-3	7"	500	1000
STQ-2016-3Z	7"	500	1000



Caution: ESD Sensitive

Appropriate precaution in handling, packaging and testing devices must be observed.



Typical Device Performance Graphs
 Baseband Signal: W-CDMA Test Model 1 w/ 64 DPCH,
 Peak-to-Average Ratio = 10.54

STQ-2016-3 Direct Quadrature Modulator

Broadband Noise Floor

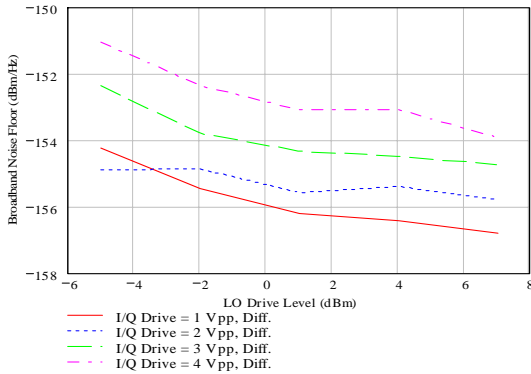

Figure 1. Broadband Noise Floor (60 MHz Offset) Vs. LO Drive Level, LO Frequency = 2140 MHz.

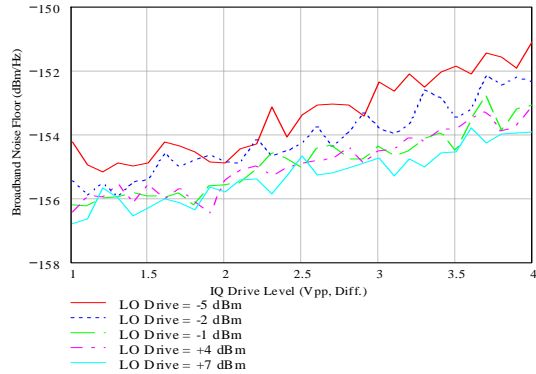

Figure 2. Broadband Noise Floor (60 MHz Offset) Vs. I/Q Drive Level, LO Frequency = 2140 MHz.

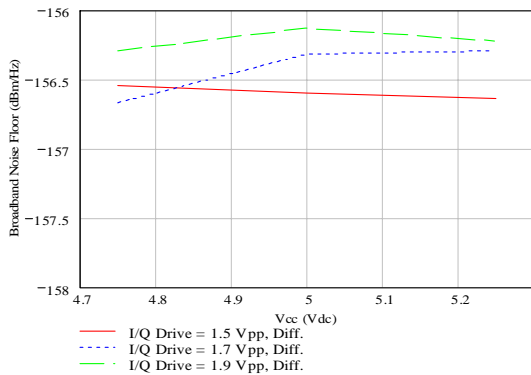

Figure 3. Broadband Noise Floor (60 MHz Offset) Vs. Vcc, LO Drive = +4.0 dBm @ 2140 MHz.

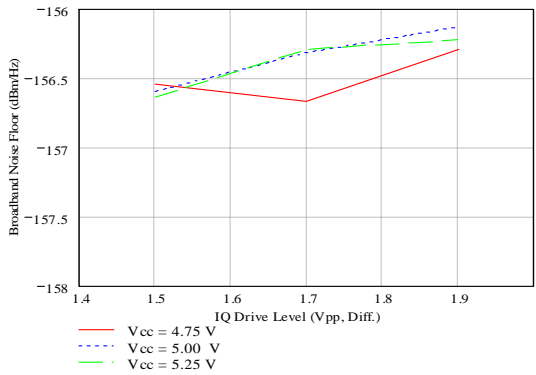

Figure 4. Broadband Noise Floor (60 MHz Offset) Vs. I/Q Drive Level, over Vcc Range, LO Drive = +4.0 dBm @ 2140 MHz.

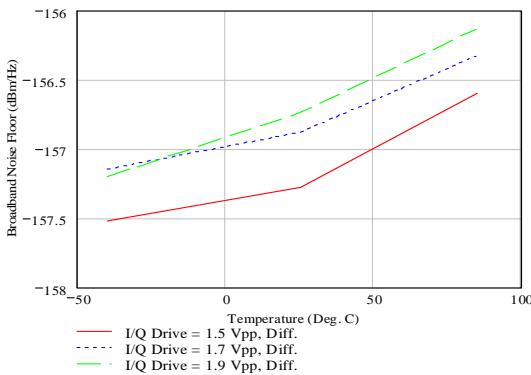

Figure 5. Broadband Noise Floor (60 MHz Offset) Vs. Temperature, LO Drive = +4.0 dBm @ 2140 MHz.

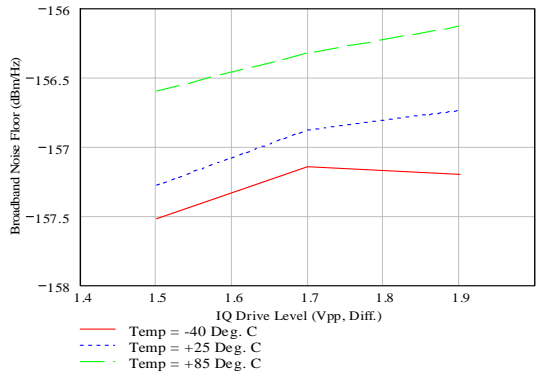

Figure 6. Broadband Noise Floor (60 MHz Offset) Vs. I/Q Drive Level, over Temperature, LO Drive = +4.0 dBm @ 2140 MHz.



Typical Device Performance Graphs
 Baseband Signal: W-CDMA Test Model 1 w/ 64 DPCH,
 Peak-to-Average Ratio = 10.54

STQ-2016-3 Direct Quadrature Modulator

Signal-to-Noise Ratio

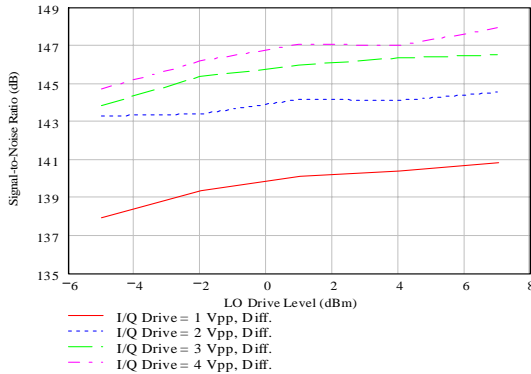

Figure 7. Signal-to-Noise Ratio Vs. LO Drive Level, LO Frequency = 2140 MHz.

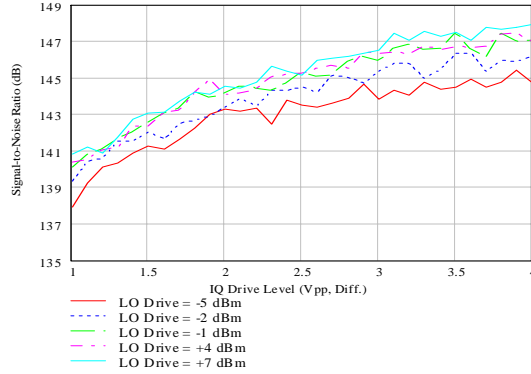

Figure 8. Signal-to-Noise Ratio Vs. I/Q Drive Level, LO Frequency = 2140 MHz.

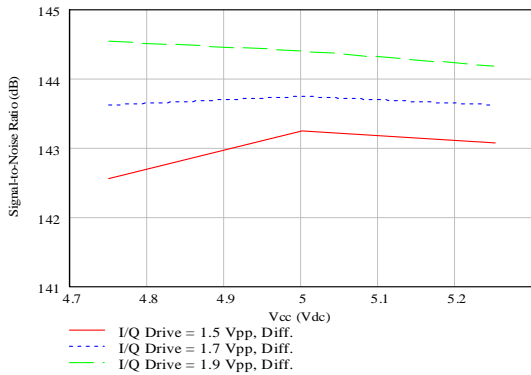

Figure 9. Signal-to-Noise Ratio Vs. Vcc, LO Drive = +4.0 dBm @ 2140 MHz.

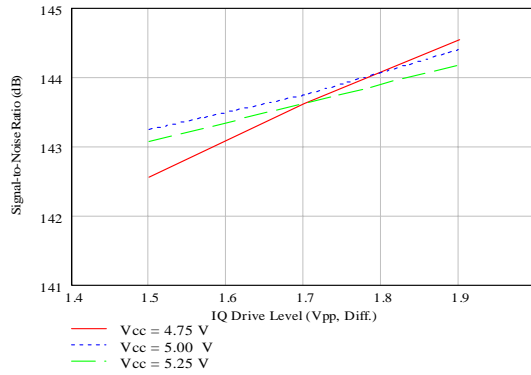

Figure 10. Signal-to-Noise Ratio Vs. I/Q Drive Level, over Vcc Range, LO Drive = +4.0 dBm @ 2140 MHz.

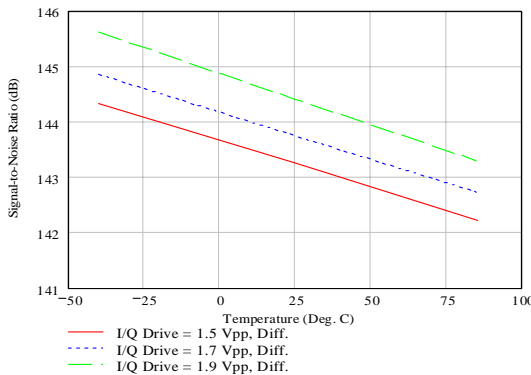

Figure 11. Signal-to-Noise Ratio Vs. Temperature, LO Drive = +4.0 dBm @ 2140 MHz.

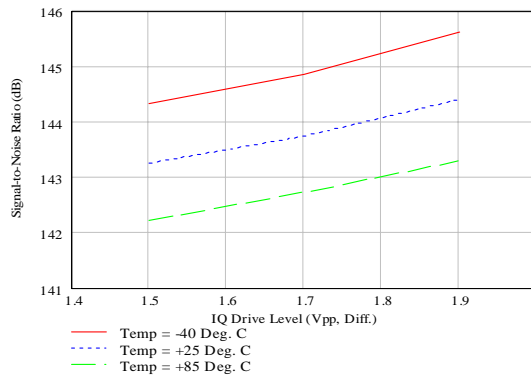

Figure 12. Signal-to-Noise Ratio Vs. I/Q Drive Level, over Temperature, LO Drive = +4.0 dBm @ 2140 MHz.



Typical Device Performance Graphs
 Baseband Signal: W-CDMA Test Model 1 w/ 64 DPCH,
 Peak-to-Average Ratio = 10.54

STQ-2016-3 Direct Quadrature Modulator

Channel Power

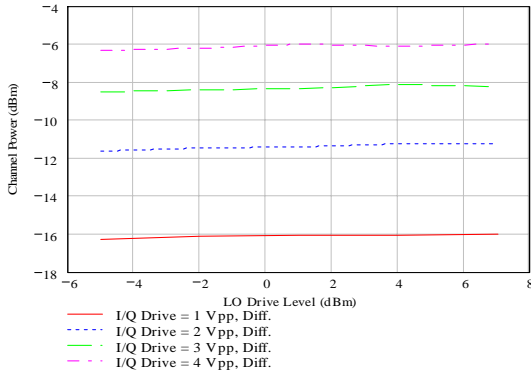

Figure 13. Channel Power Vs. LO Drive Level, LO Frequency = 2140 MHz.

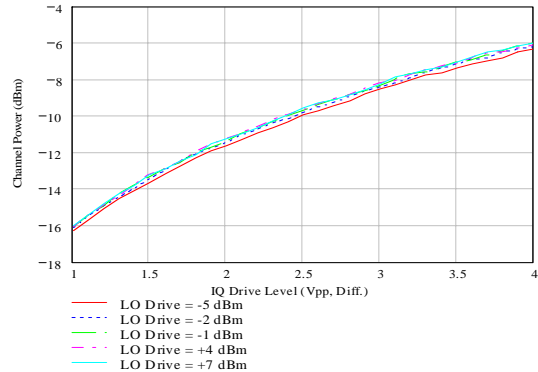

Figure 14. Channel Power Vs. I/Q Drive Level, LO Frequency = 2140 MHz.

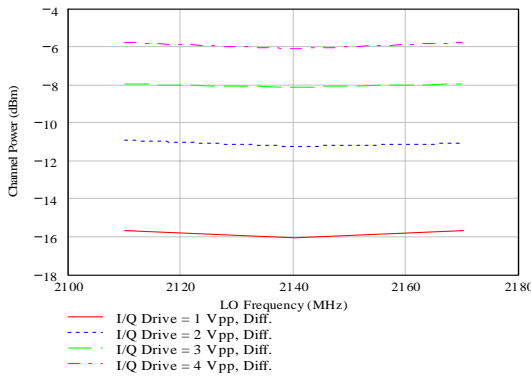

Figure 15. Channel Power Vs. LO Frequency, LO Drive = +4.0 dBm.

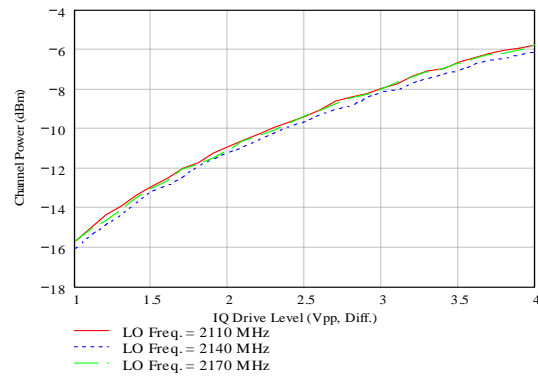

Figure 16. Channel Power Vs. I/Q Drive Level, over LO Frequency Range, LO Drive = +4.0 dBm.

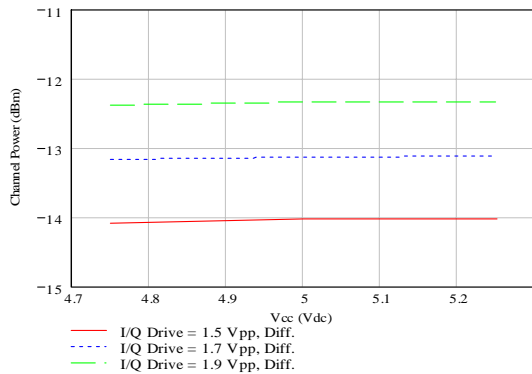

Figure 17. Channel Power Vs. Vcc, LO Drive = +4.0 dBm @ 2140 MHz.

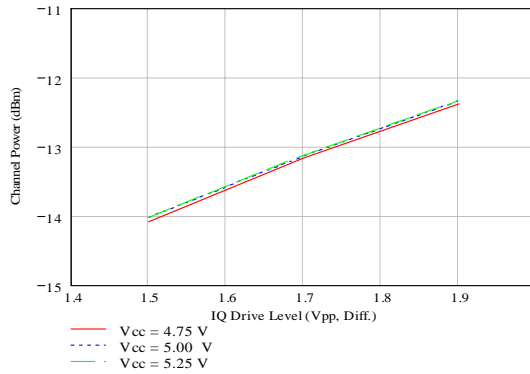

Figure 18. Channel Power Vs. I/Q Drive Level, over Vcc Range, LO Drive = +4.0 dBm @ 2140 MHz.



Typical Device Performance Graphs
 Baseband Signal: W-CDMA Test Model 1 w/ 64 DPCH,
 Peak-to-Average Ratio = 10.54

STQ-2016-3 Direct Quadrature Modulator

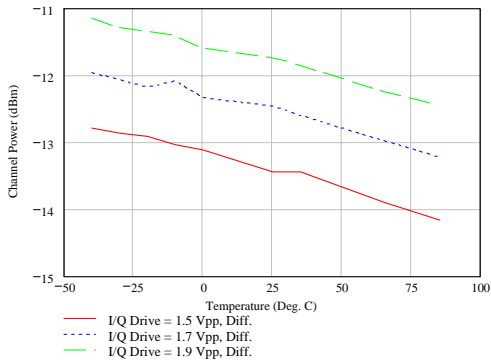

Figure 19. Channel Power Vs. Temperature, LO Drive = +4.0 dBm @ 2140 MHz.

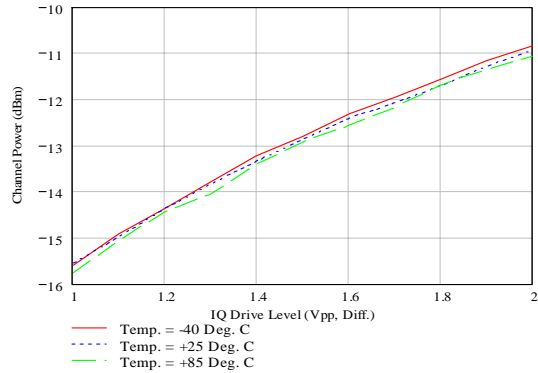

Figure 20. Channel Power Vs. I/Q Drive Level, over Temperature Range, LO Drive = +4.0 dBm @ 2140 MHz.

Adjacent Channel Power

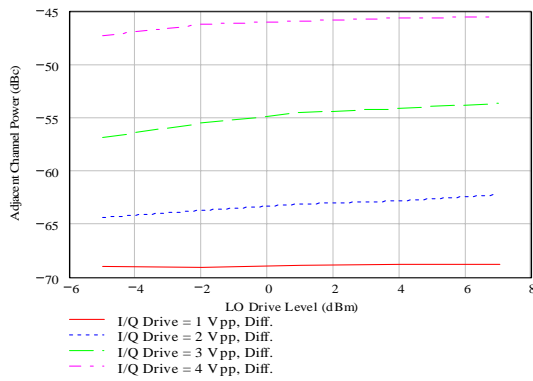

Figure 21. Adjacent Channel Power Vs. LO Drive Level, LO Frequency = 2140 MHz.

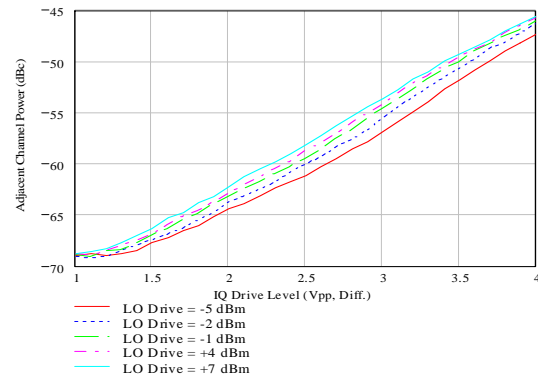

Figure 22. Adjacent Channel Power Vs. I/Q Drive Level, LO Frequency = 2140 MHz.

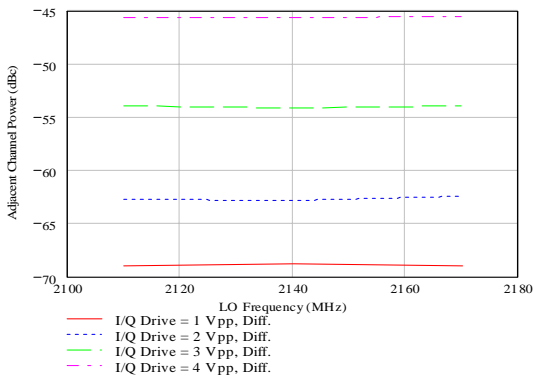

Figure 23. Adjacent Channel Power Vs. LO Frequency, LO Drive = +4.0 dBm.

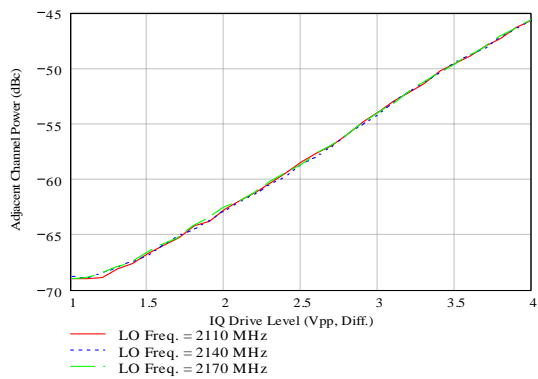

Figure 24. Adjacent Channel Power Vs. I/Q Drive Level, over LO Frequency Range, LO Drive = +4.0 dBm.



Typical Device Performance Graphs

Baseband Signal: W-CDMA Test Model 1 w/ 64 DPCH,
Peak-to-Average Ratio = 10.54

STQ-2016-3 Direct Quadrature Modulator

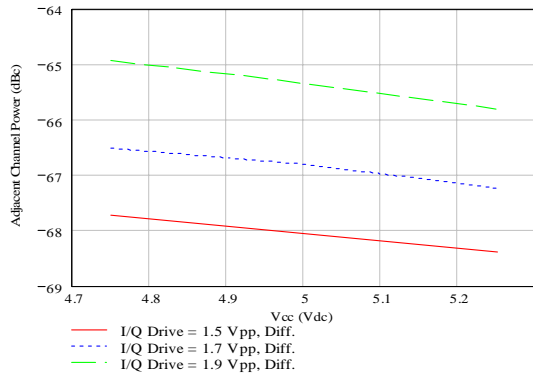

Figure 25. Adjacent Channel Power Vs. Vcc, LO Drive = +4.0 dBm @ 2140 MHz.

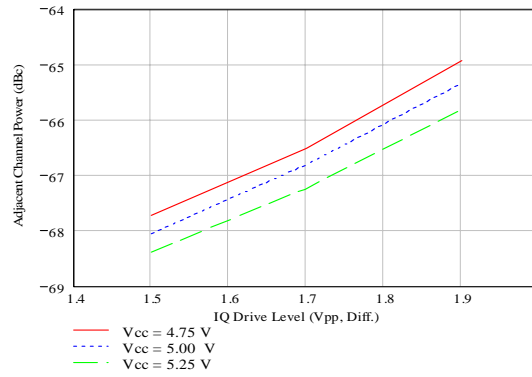

Figure 26. Adjacent Channel Power Vs. I/Q Drive Level, over Vcc Range, LO Drive = +4.0 dBm @ 2140 MHz.

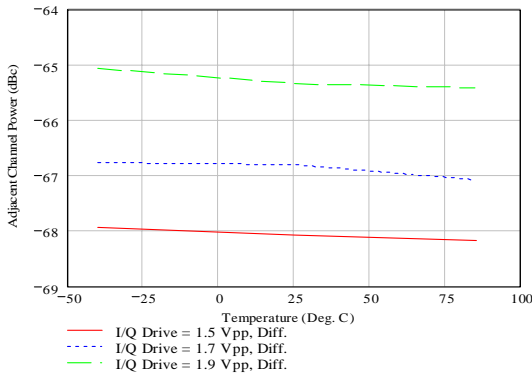

Figure 27. Adjacent Channel Power Vs. Temperature, LO Drive = +4.0 dBm @ 2140 MHz.

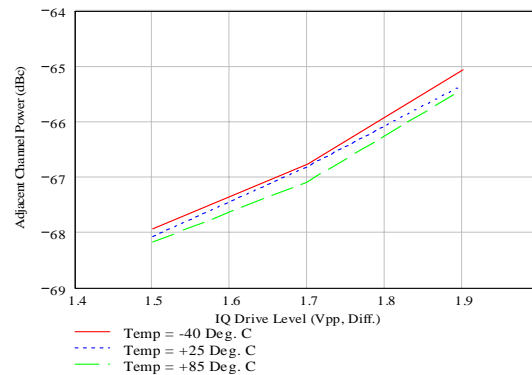

Figure 28. Adjacent Channel Power Vs. I/Q Drive Level, over Temperature Range, LO Drive = +4.0 dBm @ 2140 MHz.

First Alternate Channel Power

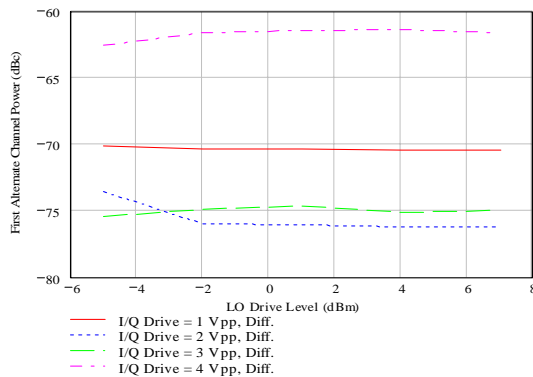

Figure 29. First Alternate Channel Power Vs. LO Drive Level, LO Frequency = 2140 MHz.

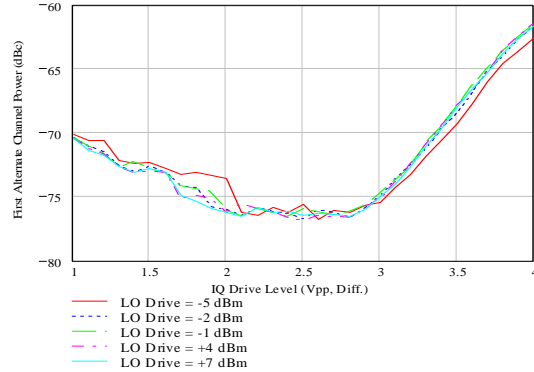

Figure 30. First Alternate Channel Power Vs. I/Q Drive Level, LO Frequency = 2140 MHz.



Typical Device Performance Graphs
 Baseband Signal: W-CDMA Test Model 1 w/ 64 DPCH,
 Peak-to-Average Ratio = 10.54

STQ-2016-3 Direct Quadrature Modulator

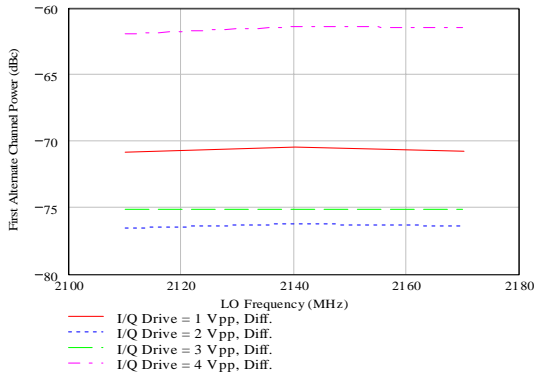

Figure 31. First Alternate Channel Power Vs. LO Frequency, LO Drive = +4.0 dBm.

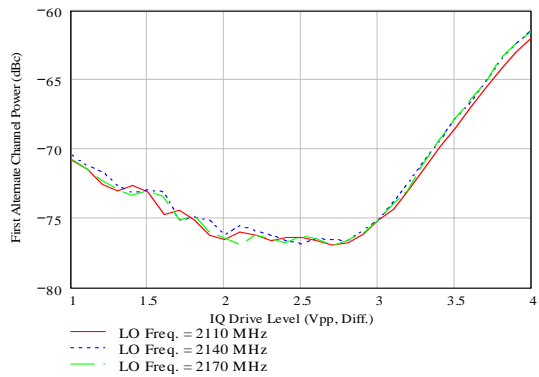

Figure 32. First Alternate Channel Power Vs. I/Q Drive Level, LO Drive = +4.0 dBm.

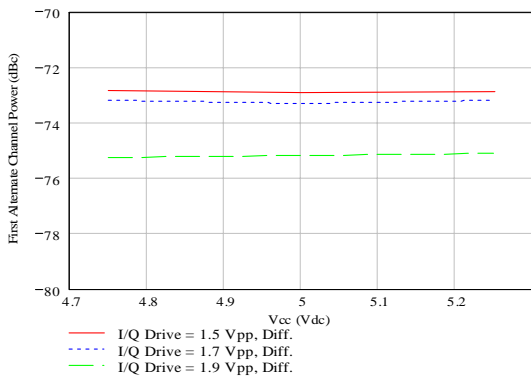

Figure 33. First Alternate Channel Power Vs. Vcc, LO Drive = +4.0 dBm @ 2140 MHz.

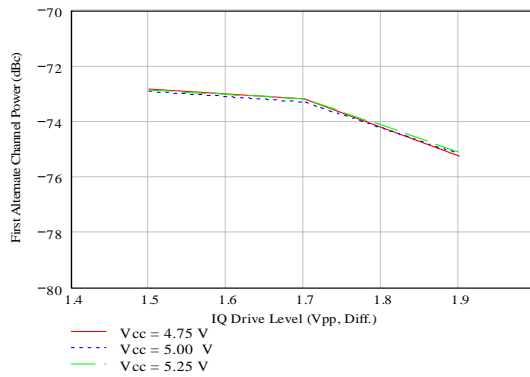

Figure 34. First Alternate Channel Power Vs. I/Q Drive Level, over Vcc Range, LO Drive = +4.0 dBm @ 2140 MHz.

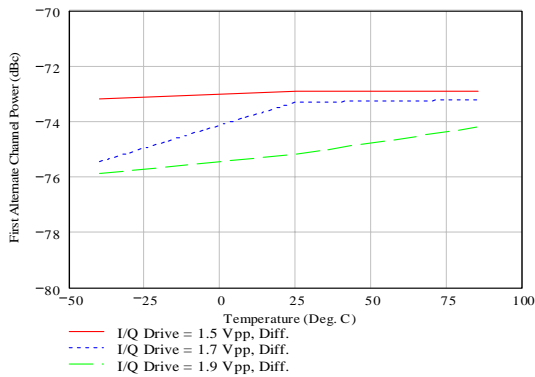

Figure 35. First Alternate Channel Power Vs. Temperature, LO Drive = +4.0 dBm @ 2140 MHz.

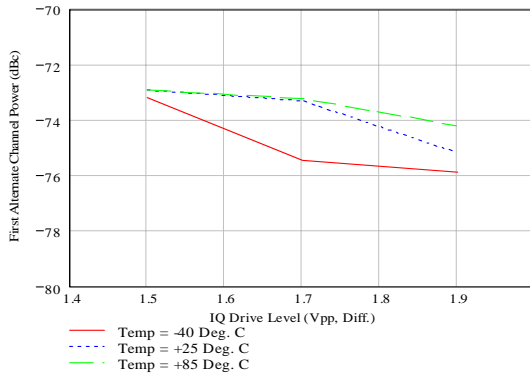

Figure 36. First Alternate Channel Power Vs. I/Q Drive Level, over Temperature Range, LO Drive = +4.0 dBm @ 2140 MHz.



Typical Device Performance Graphs

Baseband Signal: W-CDMA Test Model 1 w/ 64 DPCH,
Peak-to-Average Ratio = 10.54

STQ-2016-3 Direct Quadrature Modulator

Second Alternate Channel Power

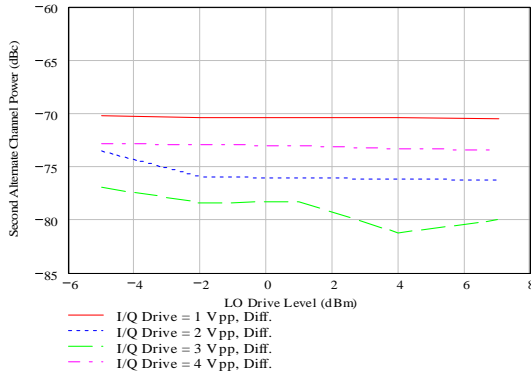

Figure 37. Second Alternate Channel Power Vs. LO Drive Level, LO Frequency = 2140 MHz.

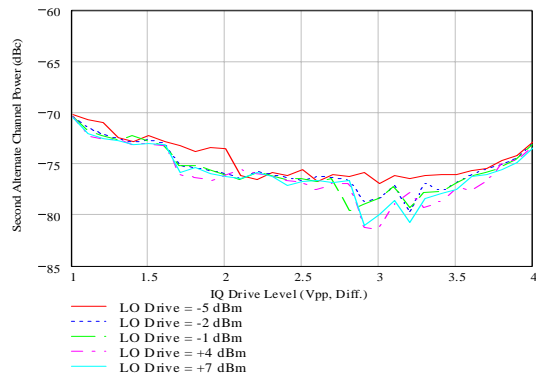

Figure 38. Second Alternate Channel Power Vs. I/Q Drive Level, LO Frequency = 2140 MHz.

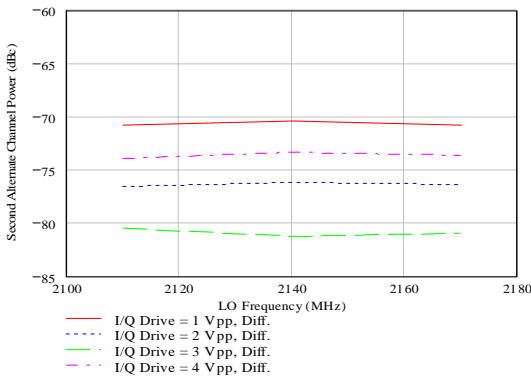

Figure 39. Second Alternate Channel Power Vs. LO Frequency, LO Drive = +4.0 dBm.

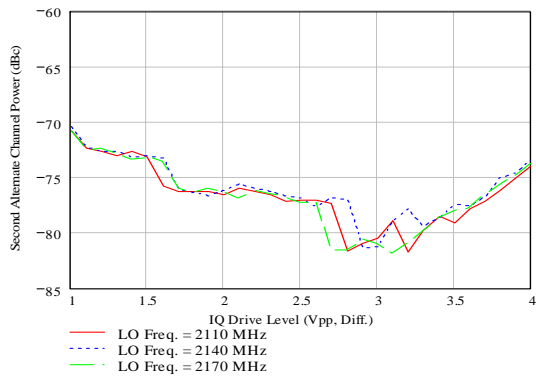

Figure 40. Second Alternate Channel Power Vs. I/Q Drive Level, LO Drive = +4.0 dBm.

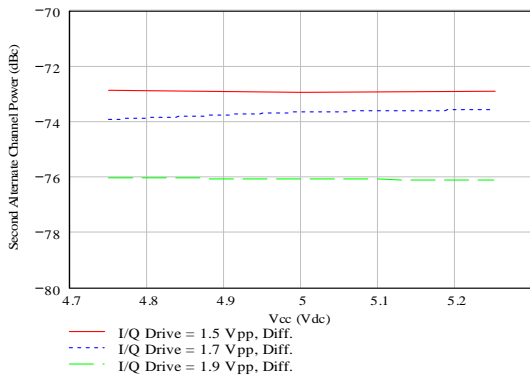

Figure 41. Second Alternate Channel Power Vs. Vcc, LO Drive = +4.0 dBm @ 2140 MHz.

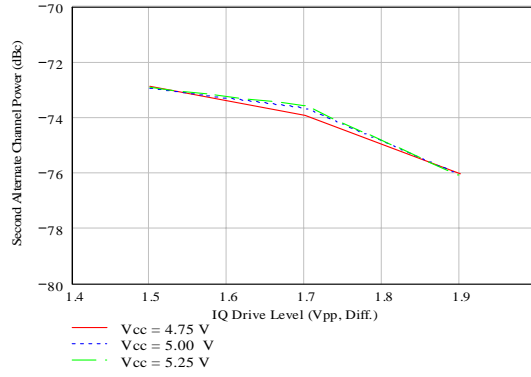

Figure 42. Second Alternate Channel Power Vs. I/Q Drive Level, over Vcc Range, LO Drive = +4.0 dBm @ 2140 MHz.



Typical Device Performance Graphs
 Baseband Signal: W-CDMA Test Model 1 w/ 64 DPCH,
 Peak-to-Average Ratio = 10.54

STQ-2016-3 Direct Quadrature Modulator

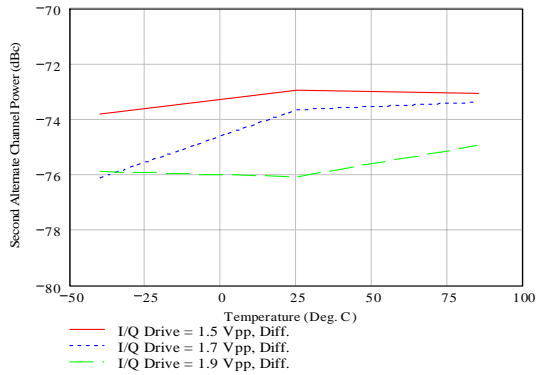

Figure 43. Second Alternate Channel Power Vs. Temperature, LO Drive = +4.0 dBm @ 2140 MHz.

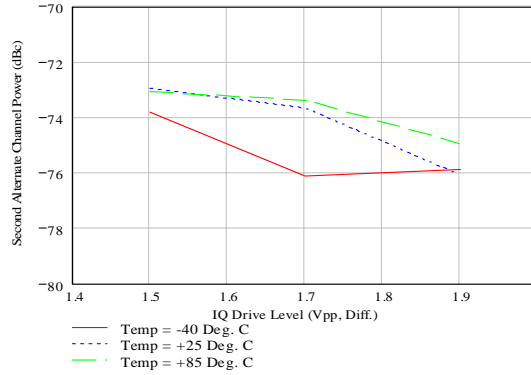

Figure 44. Second Alternate Channel Power Vs. I/Q Drive Level, over Temperature Range, LO Drive = +4.0 dBm @ 2140 MHz.

Typical Performance Distribution Over Multiple Lots

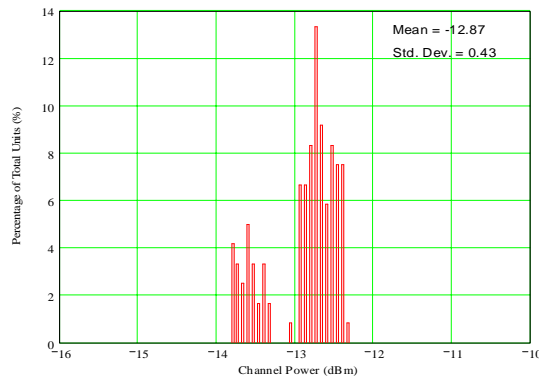

Figure 45. Channel Power Distribution, 4 Production Lots, 120 Units. LO Drive = +4.0 dBm @ 2140 MHz. I/Q Drive Level = 1.7 Vpp, Diff.

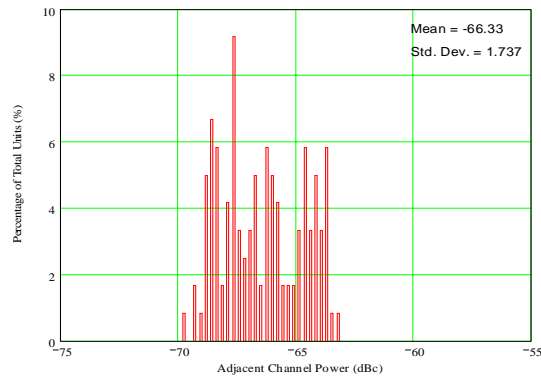

Figure 46. Adjacent Channel Power Distribution, 4 Production Lots, 120 Units. LO Drive = +4.0 dBm @ 2140 MHz. I/Q Drive Level = 1.7 Vpp, Diff.

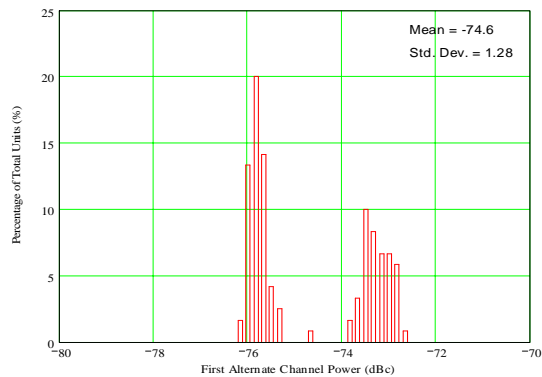

Figure 47. First Alternate Channel Power Distribution, 4 Production Lots, 120 Units. LO Drive = +4.0 dBm @ 2140 MHz. I/Q Drive Level = 1.7 Vpp, Diff.

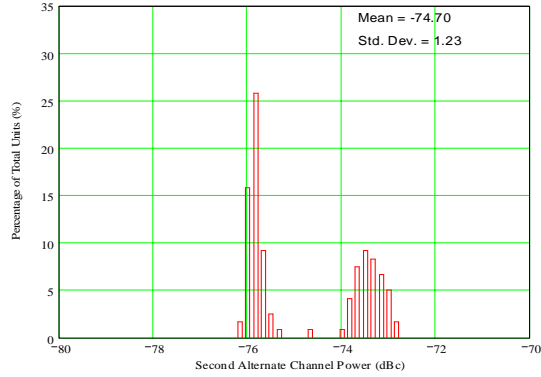

Figure 48. Second Alternate Channel Power Distribution, 4 Production Lots, 120 Units. LO Drive = +4.0 dBm @ 2140 MHz. I/Q Drive Level = 1.7 Vpp, Diff.

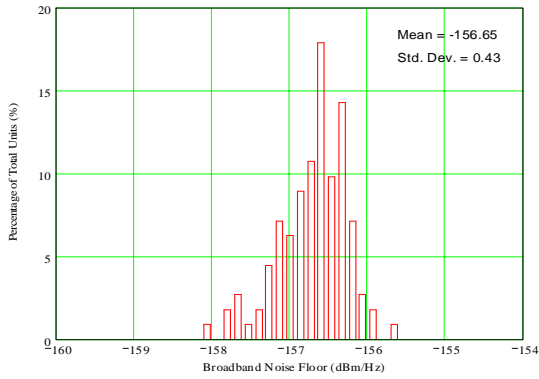

Figure 49. Broadband Noise Floor (60 MHz Offset) Distribution, 4 Production Lots, 120 Units. LO Drive = +4.0 dBm @ 2140 MHz. I/Q Drive Level = 1.7 Vpp, Diff.

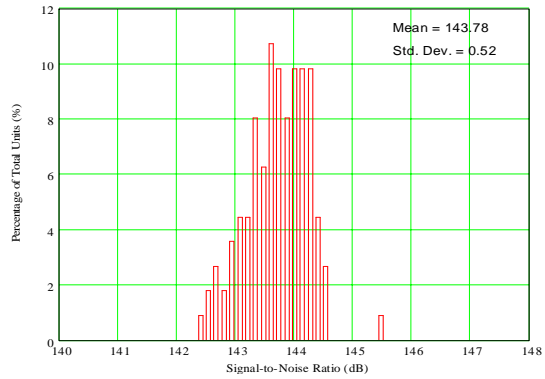
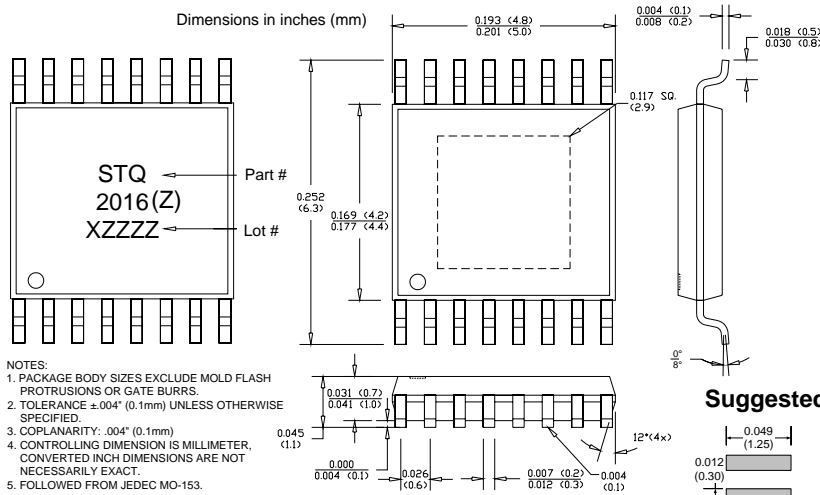
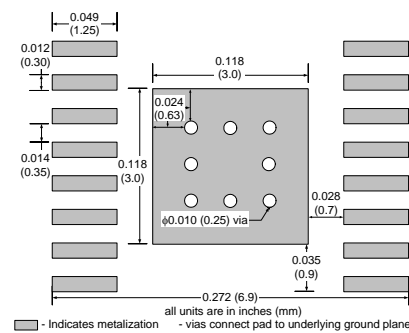

Figure 50. Signal-to-Noise Ratio (60 MHz Offset) Distribution, 4 Production Lots, 120 Units. LO Drive = +4.0 dBm @ 2140 MHz. I/Q Drive Level = 1.7 Vpp, Diff.

Package Dimensions (“16” Package)



Suggested PCB Pad Layout



700 – 1000 MHz Application Schematic

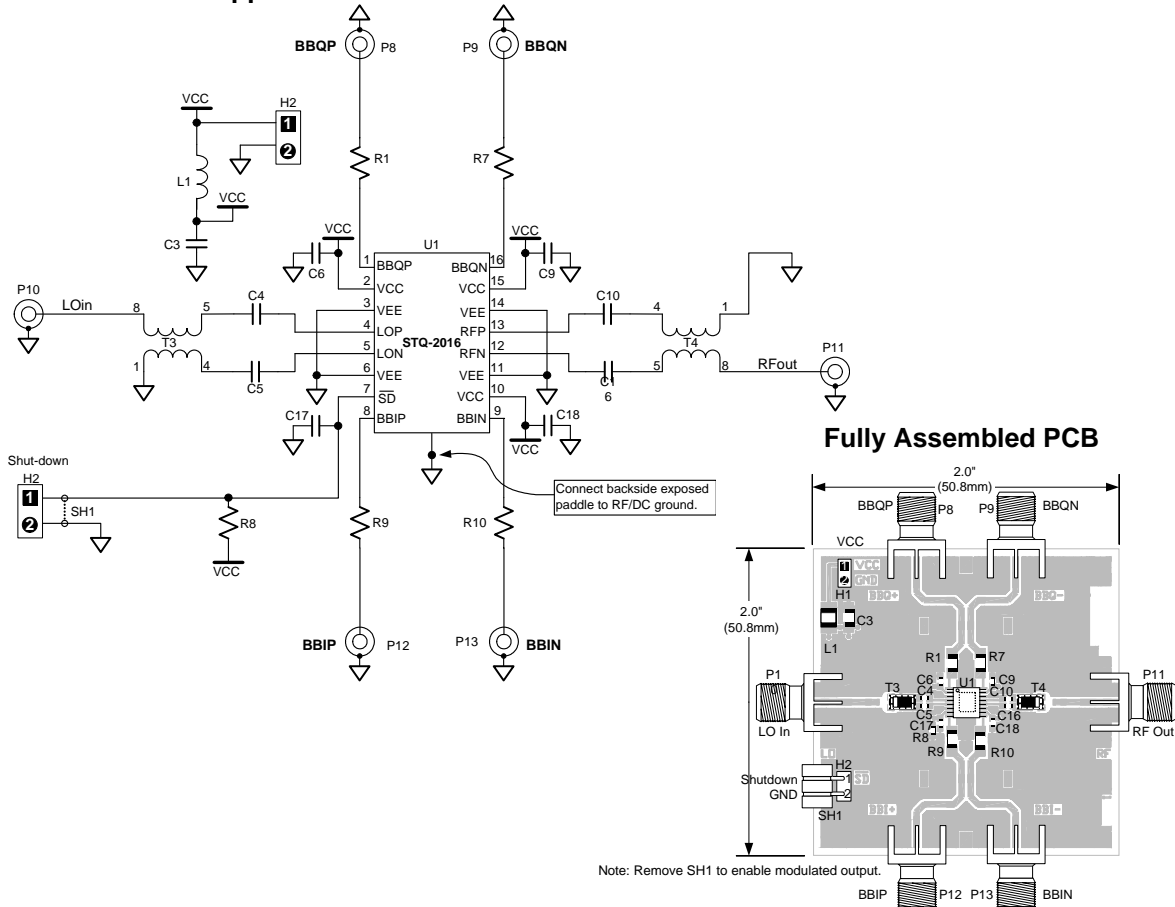

Bill of Materials (for 700 – 1000 MHz Evaluation Board P/N STQ-2016-3EVB-1)

Component Designator	Value	Qty	Vendor	Part Number	Description
U1		1	SMDI	STQ-2016	SiGe Direct Quadrature Modulator
P8, P9, P10, P11, P12, P13		6	Johnson Components	142-0701-851	SMA connector, end launch with tab, for .062" thick board
H1, H2		2	AMP	640453-2	2-pin header, right angle
T3, T4	1:1	2	Panasonic	EHF-FD1618	RF transformer, 700-1300MHz
L1	1uH	1	Panasonic	ELJ-FA1R0KF2	Inductor, 1210 footprint, ±10% tolerance
R1, R7, R9, R10	200 ohm	4	Venkel	CR1206-8W-2000T	Resistor, 1206 footprint, ±1% tolerance
R8	1 kohm	1	Venkel	CR0603-16W-1001FT	Resistor, 0603 footprint, ±1% tolerance
C6, C18	33pF	2	Venkel	C0603COG500-330JNE	Capacitor, 0603 footprint, COG dielectric, ±5% tolerance
C9, C17	1nF	2	Venkel	C0603COG500-102JNE	Capacitor, 0603 footprint, COG dielectric, ±5% tolerance
C3	2.2uF	1	Venkel	C1206Y5V160-225ZNE	Capacitor, 1206 footprint, Y5V dielectric, 16V rating
C4, C5, C10, C16	10pF	4	Venkel	C0603COG500-100JNE	Capacitor, 0603 footprint, COG dielectric, ±5% tolerance
SH1		1	3M	929950-00	Shunt for 2-pin header

1.7 – 2.5 GHz Application Schematic

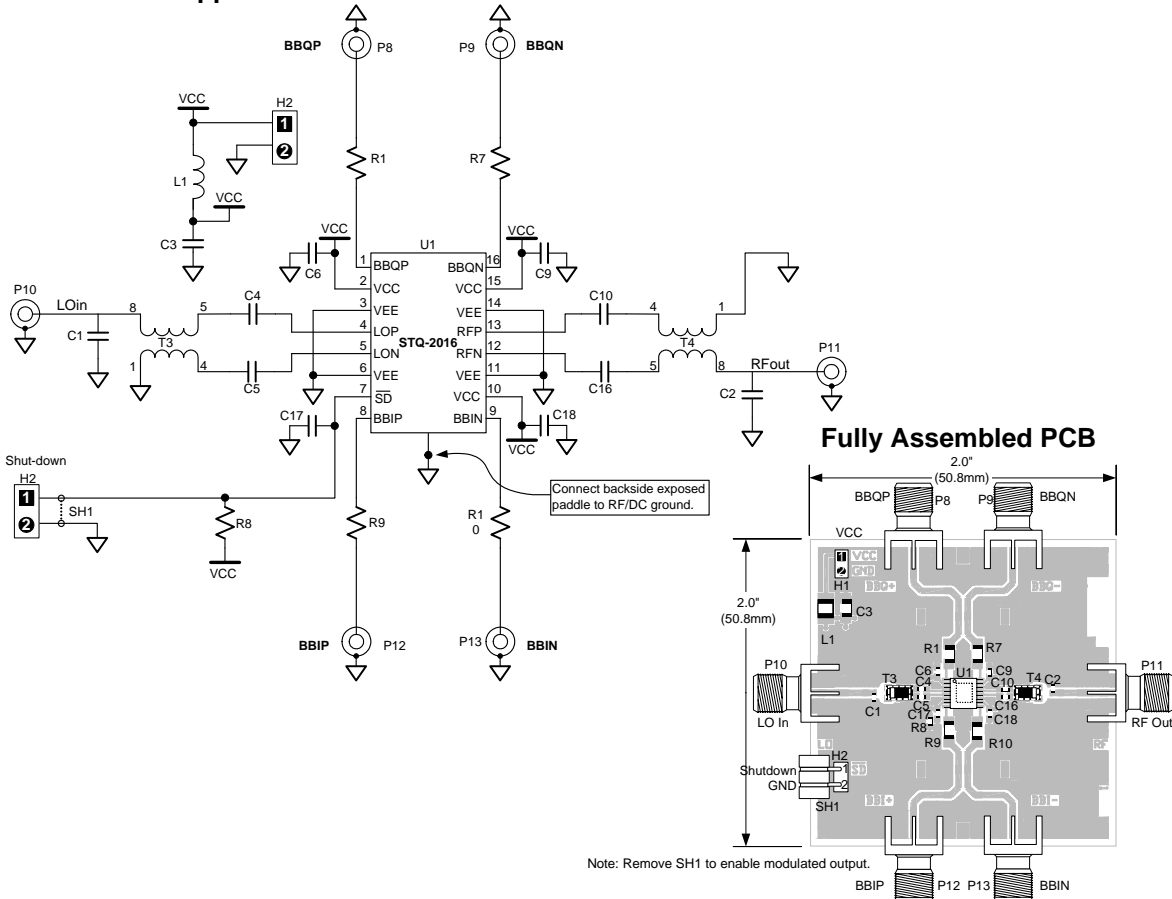

Bill of Materials (for 1.7 – 2.5 GHz Evaluation Board P/N STQ-2016-3EVB-2)

Component Designator	Value	Qty	Vendor	Part Number	Description
U1		1	SMDI	STQ-2016	SiGe Direct Quadrature Modulator
P8, P9, P10, P11, P12, P13		6	Johnson Components	142-0701-851	SMA connector, end launch with tab, for .062" thick board
H1, H2		2	AMP	640453-2	2-pin header, right angle
T3, T4	1:1	2	Panasonic	EHF-FD1619	RF transformer, 1200-2200MHz
L1	1uH	1	Panasonic	ELJ-FA1R0KF2	Inductor, 1210 footprint, ±10% tolerance
R1, R7, R9, R10	200 ohm	4	Venkel	CR1206-8W-2000T	Resistor, 1206 footprint, ±1% tolerance
R8	1 kohm	1	Venkel	CR0603-16W-1001FT	Resistor, 0603 footprint, ±1% tolerance
C1, C2	0.5pF	2	Venkel	C0603COG500-0R5CNE	Capacitor, 0603 footprint ±0.25pF tolerance
C6, C18	6.8pF	2	Venkel	C0603COG500-6R8CNE	Capacitor, 0603 footprint, COG dielectric, ±0.25pF tol.
C9, C17	1nF	2	Venkel	C0603COG500-102JNE	Capacitor, 0603 footprint, COG dielectric, ±5% tolerance
C3	2.2uF	1	Venkel	C1206Y5V160-225ZNE	Capacitor, 1206 footprint, Y5V dielectric, 16V rating
C4, C5, C10, C16	2.2pF	4	Venkel	C0603COG500-2R2CNE	Capacitor, 0603 footprint, COG dielectric, ±0.25pF tolerance
SH1		1	3M	929950-00	Shunt for 2-pin header

Figure 51. Measurement System for Modulation Performance Tests: Channel Power, Adjacent Channel Power, First Alternate Channel Power, Second Alternate Channel Power, and Broadband Noise Floor.

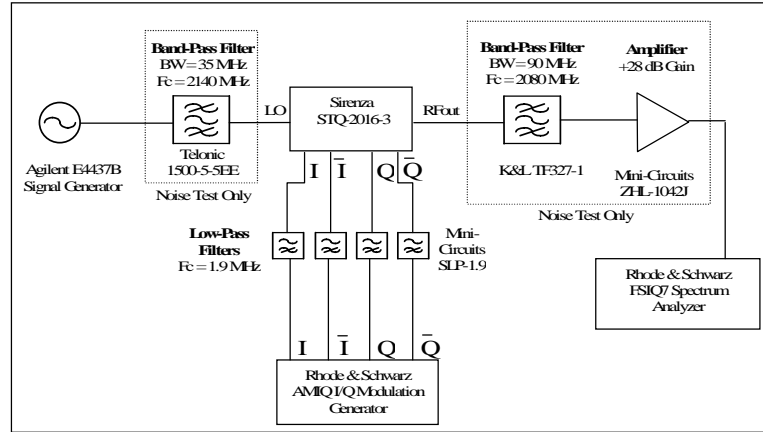

Figure 52. Measurement System for Continuous Wave Performance Tests: Output Power, P1dB, Carrier Feedthrough, Sideband Suppression, and IM3 Suppression.

